

# SPKLDS AL 70

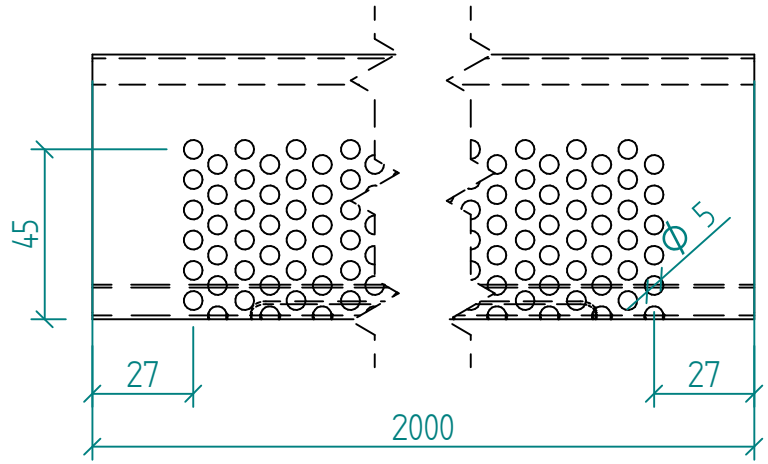

1:2

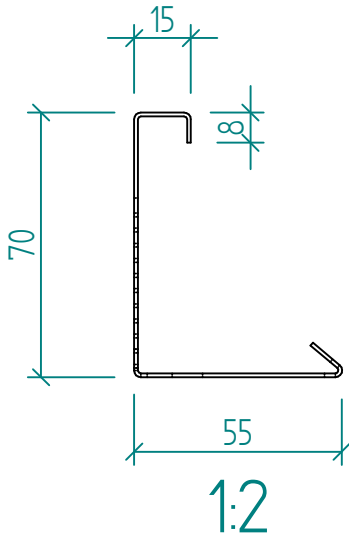
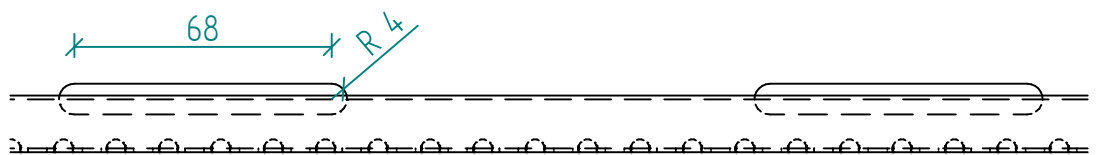
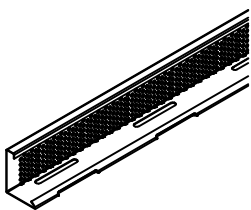

**SP PROFIL**

Název	Code	Materiál	Hmotnost	Tloušťka materiálu
SPKLDS AL 70	020401_070_AL10	Hliník AW 1050	0,707 kg	1,000 mm