

SPKLDS AL 60

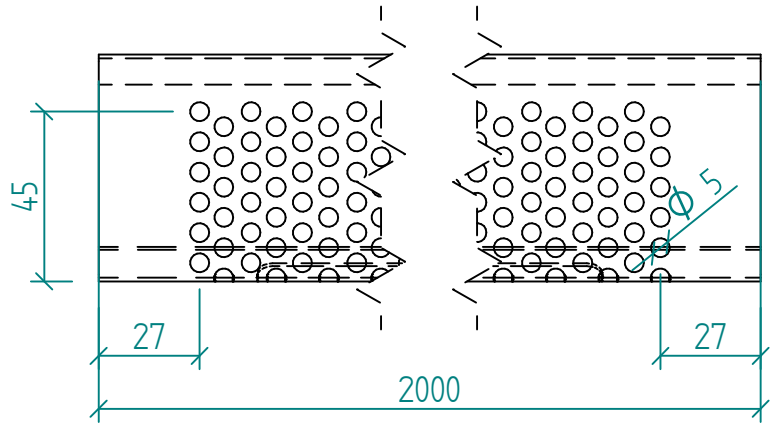

1:2

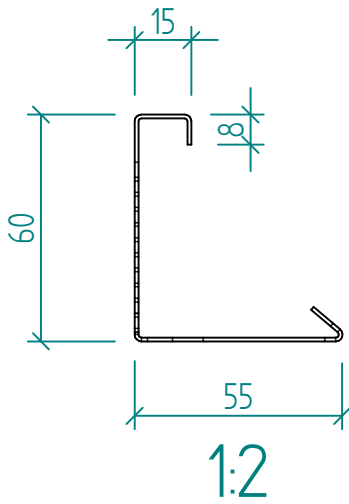
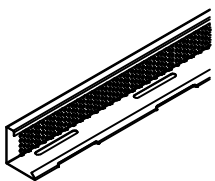
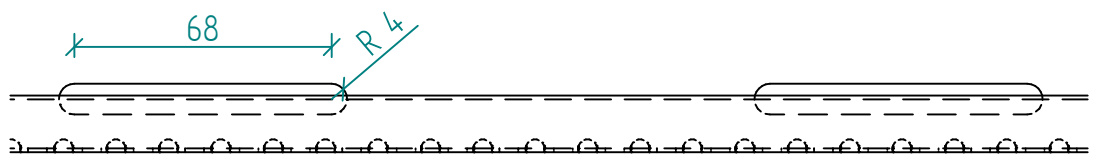

SP PROFIL

Název	Code	Materiál	Hmotnost	Tloušťka materiálu
SPKLDS AL 60	020401_060_AL10	Hliník AW 1050	0,653 kg	1,000 mm