

SPKLDS AL 130

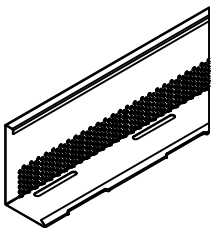
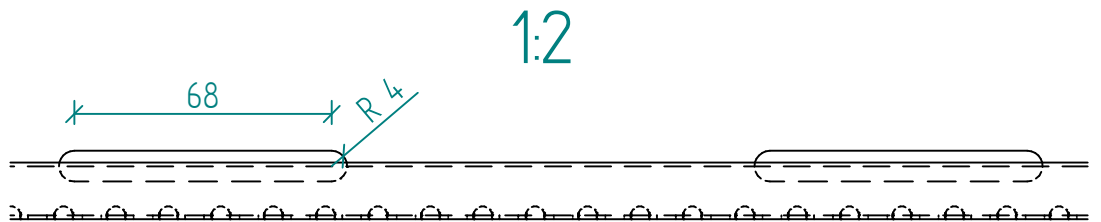
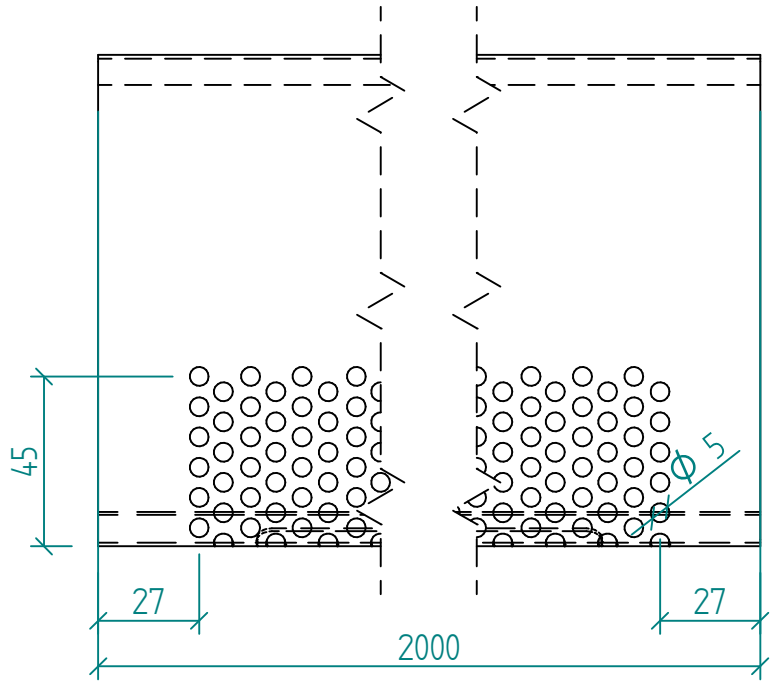
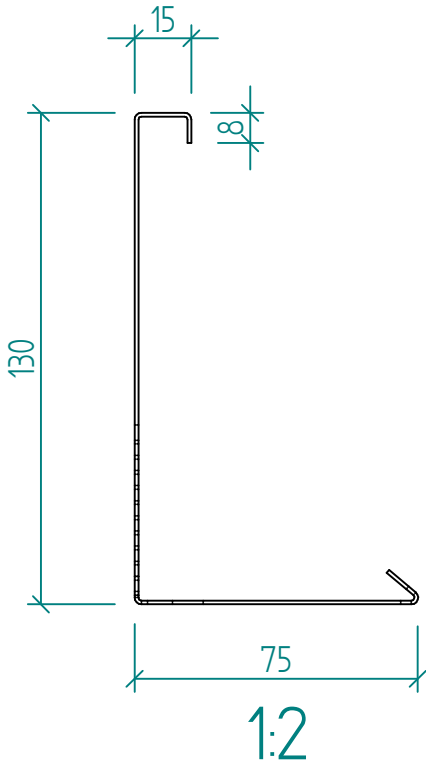

SP PROFIL

Název	Code	Materiál	Hmotnost	Tloušťka materiálu
SPKLDS AL 130	020401_130_AL10	Hliník AW 1050	1,141 kg	1,000 mm