

SPKLDS AL 120

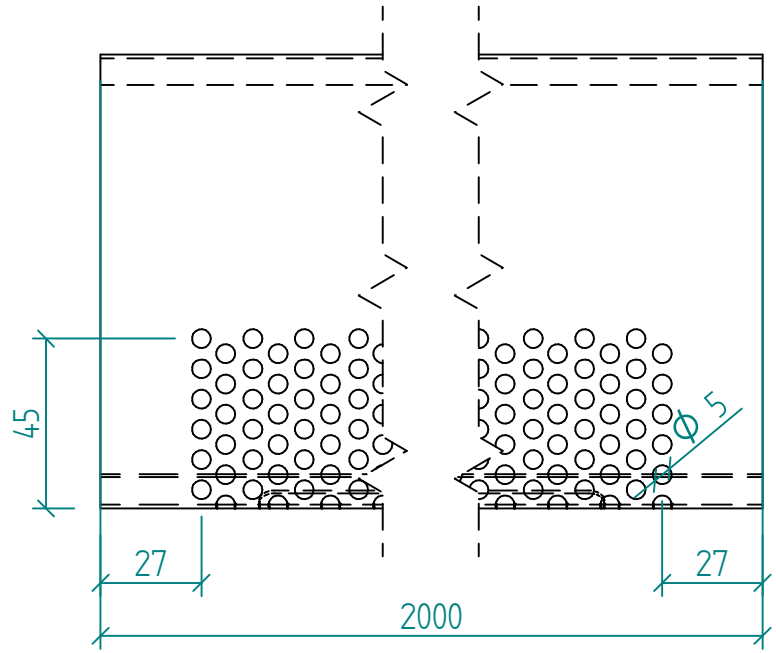

1:2

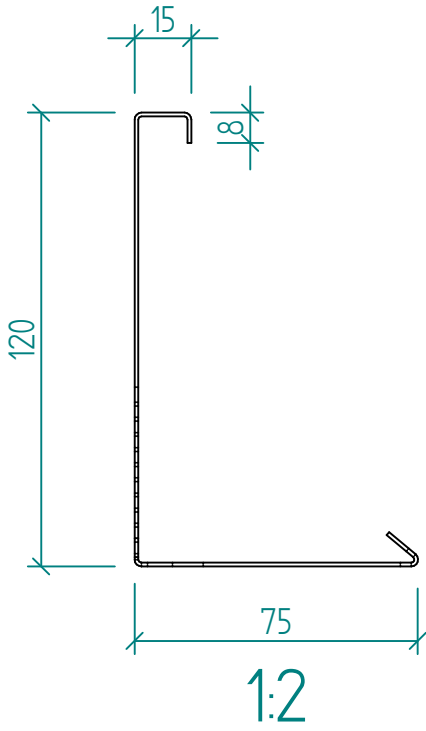
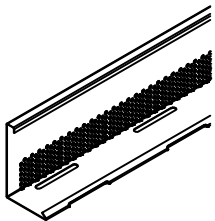
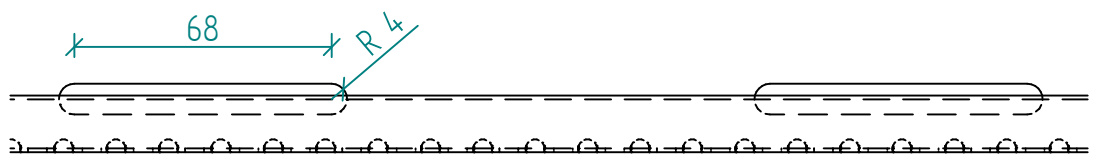

SP PROFIL

Název	Code	Materiál	Hmotnost	Tloušťka materiálu
SPKLDS AL 120	020401_120_AL10	Hliník AW 1050	1,087 kg	1,000 mm