

SPKL O AL 90

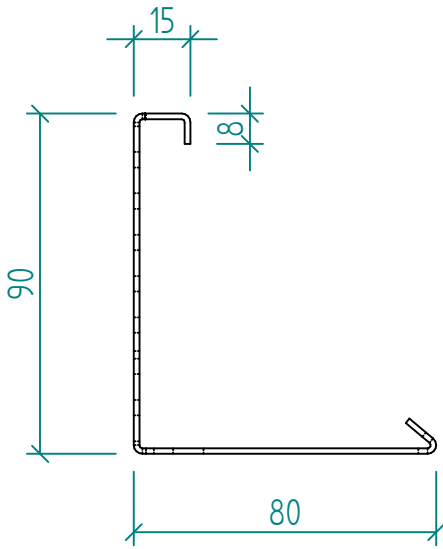

1:2

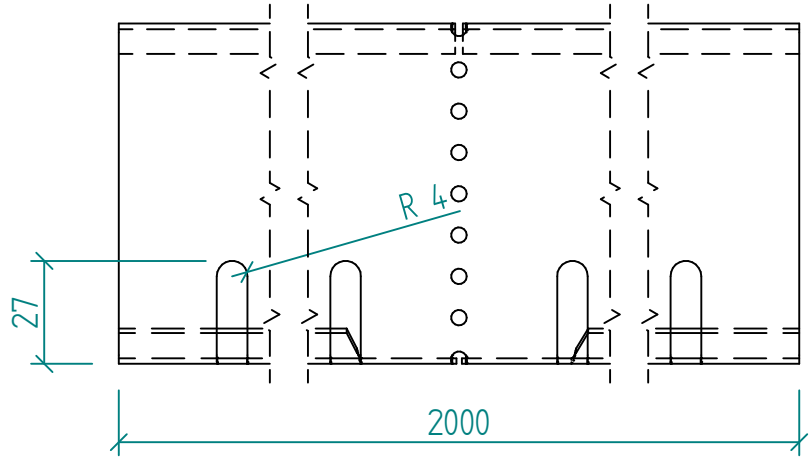

1:5

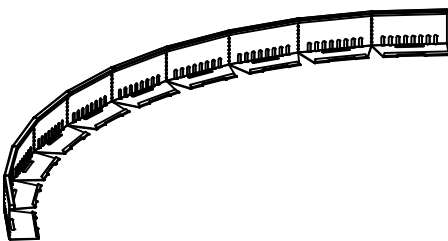
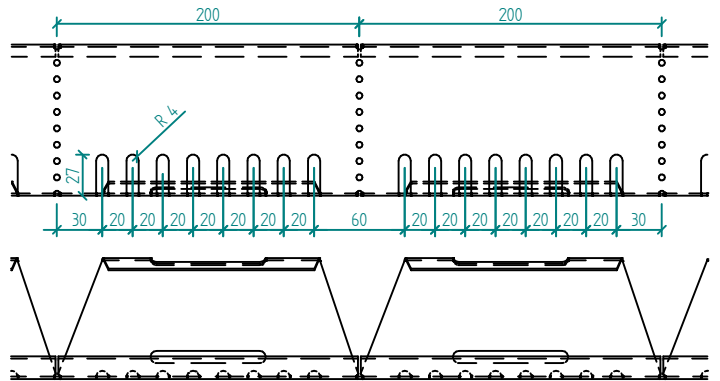

SP PROFIL

Název	Code	Materiál	Hmotnost	Tloušťka materiálu
SPKL O AL 90	020305_090_OAL15	Hliník AW 1050	1,360 kg	1,500 mm