

# SPKL O AL 80

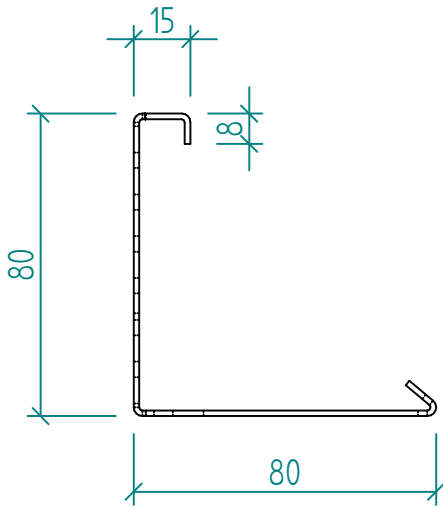

1:2

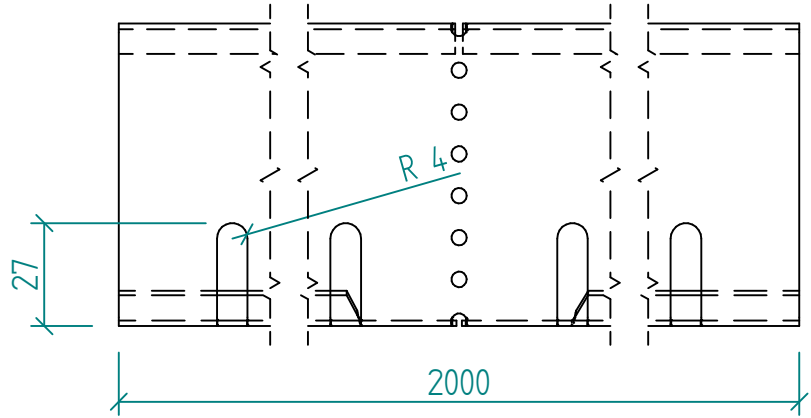

1:5

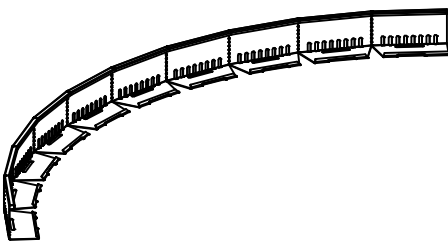
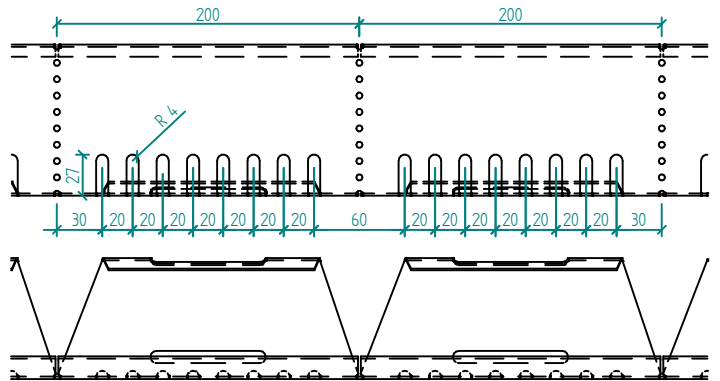

**SP PROFIL**

Název	Code	Materiál	Hmotnost	Tloušťka materiálu
SPKL O AL 80	020305_080_OAL15	Hliník AW 1050	1,279 kg	1,500 mm