

SPKL O AL 50

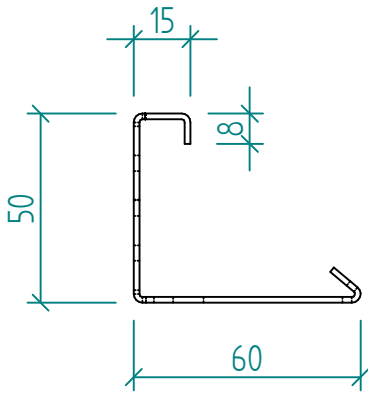

1:2

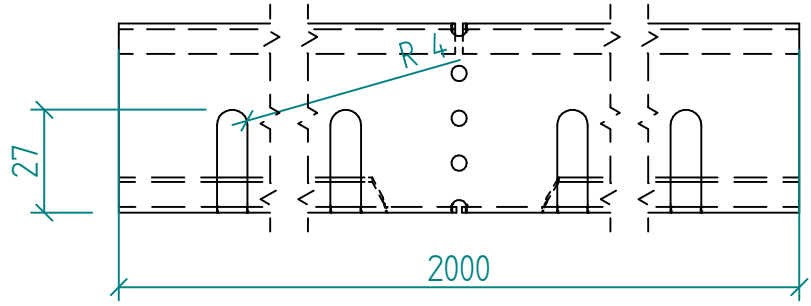

1:5

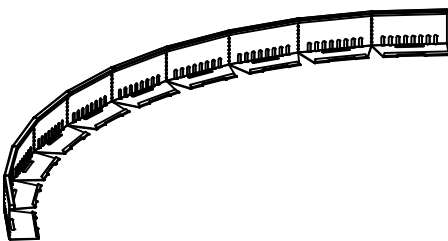
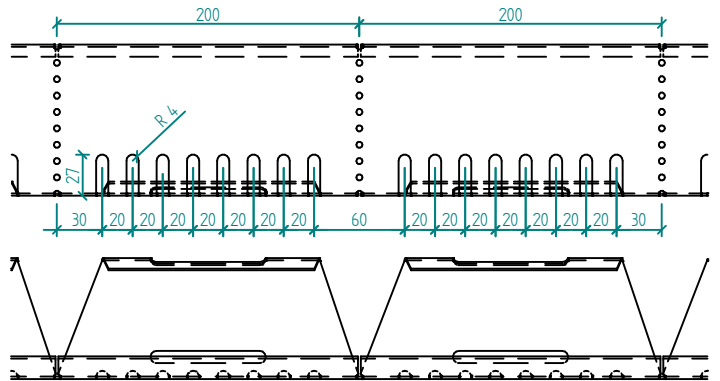

SP PROFIL

Název	Code	Materiál	Hmotnost	Tloušťka materiálu
SPKL O AL 50	020305_050_OAL15	Hliník AW 1050	0,915 kg	1,500 mm