

SPKL O AL 40

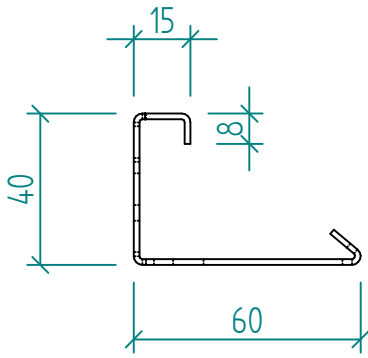

1:2

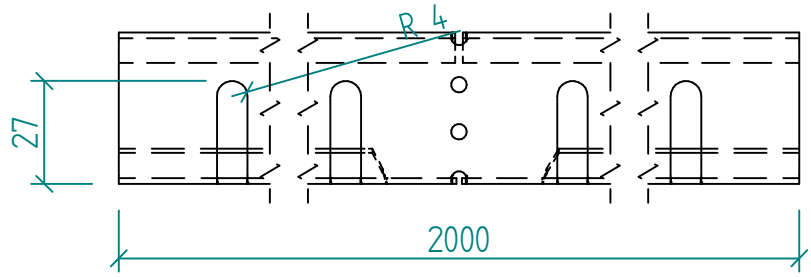

1:5

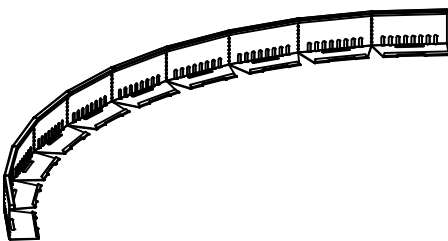
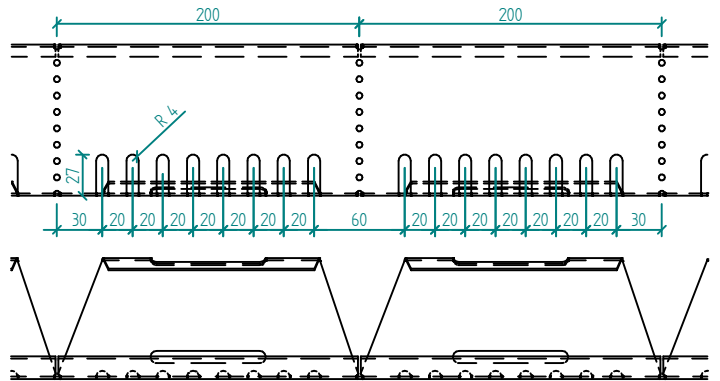

SP PROFIL

Název	Code	Materiál	Hmotnost	Tloušťka materiálu
SPKL O AL 40	020305_040_OAL15	Hliník AW 1050	0,834 kg	1,500 mm