

SPKL O AL 210

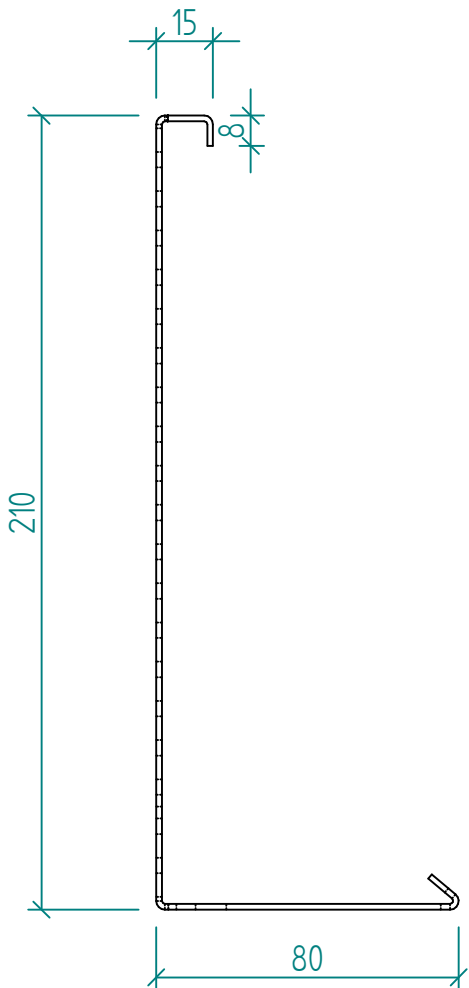

1:2

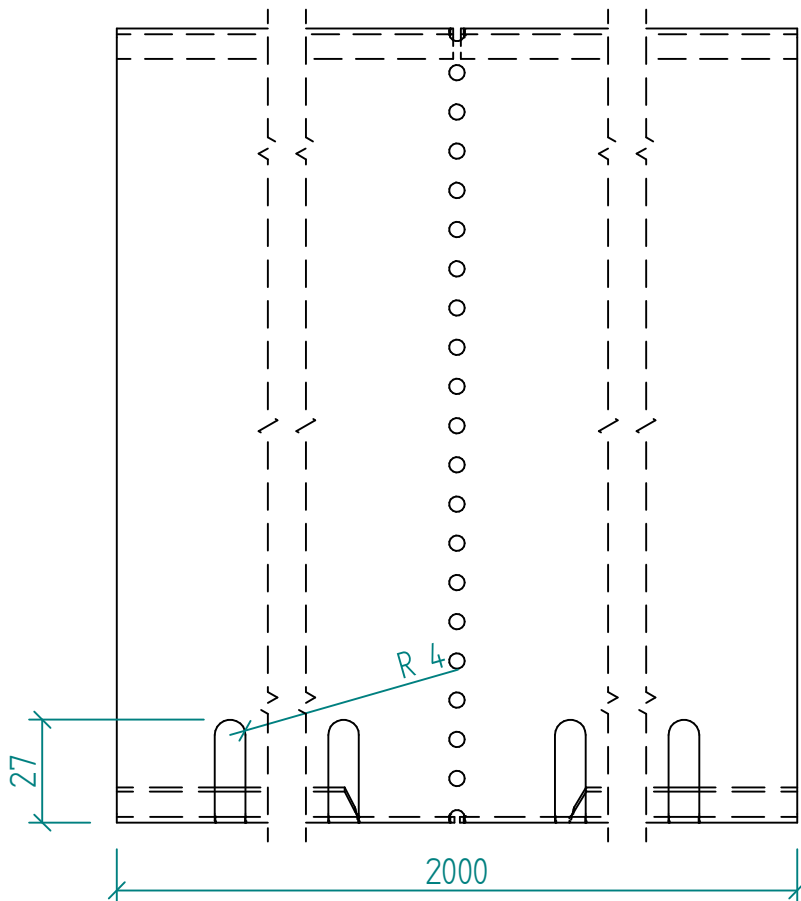

1:5

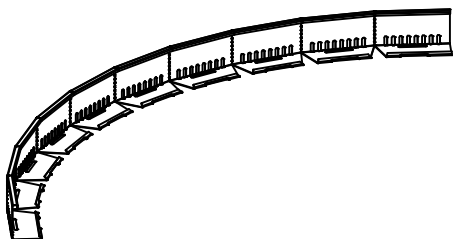
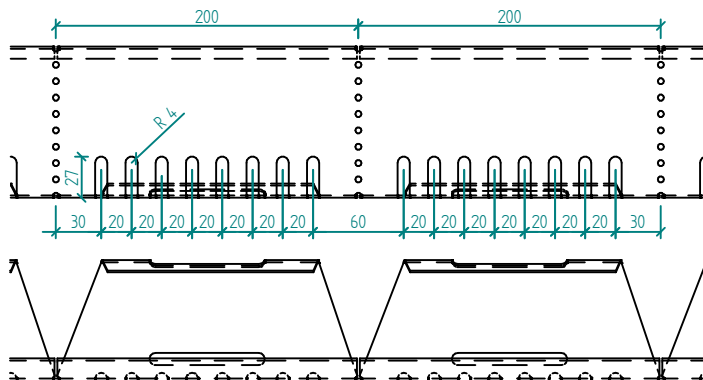

SP PROFIL

Název	Code	Materiál	Hmotnost	Tloušťka materiálu
SPKL O AL 210	020305_210_OAL15	Hliník AW 1050	2,330 kg	1,500 mm