

SPKL O AL 150

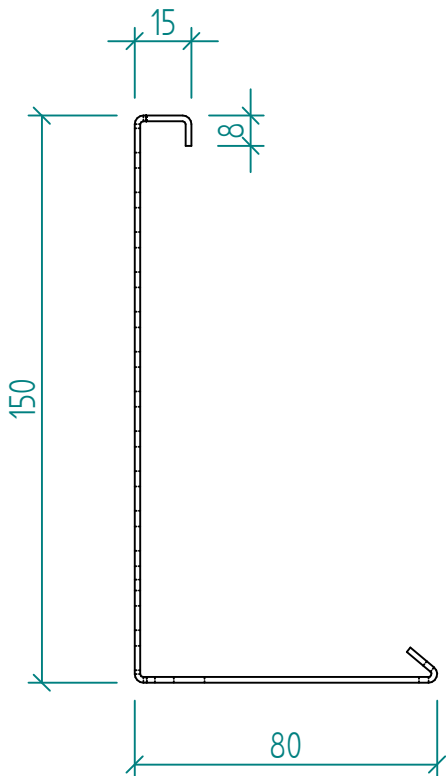

1:2

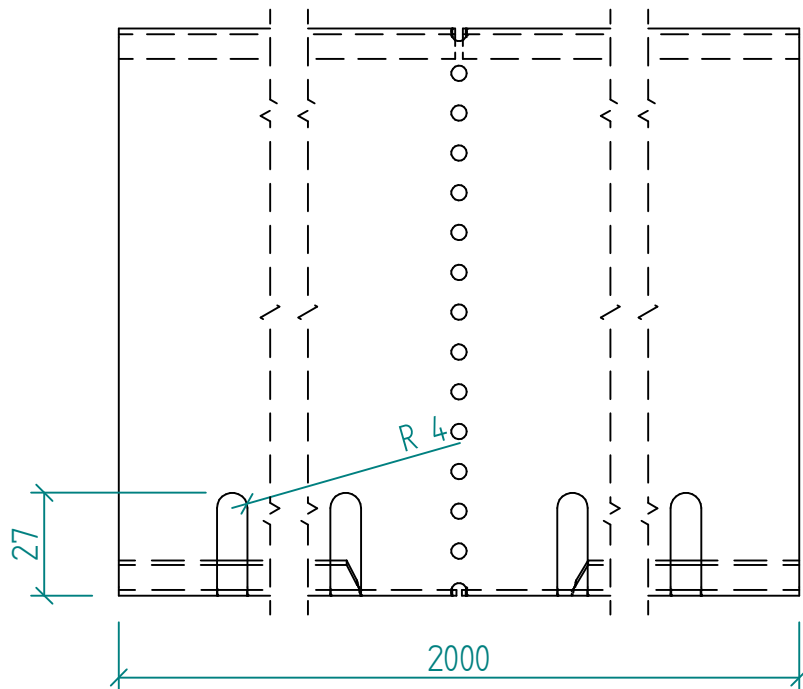

1:5

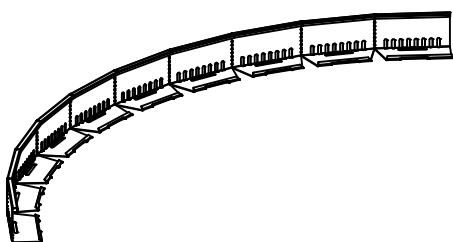
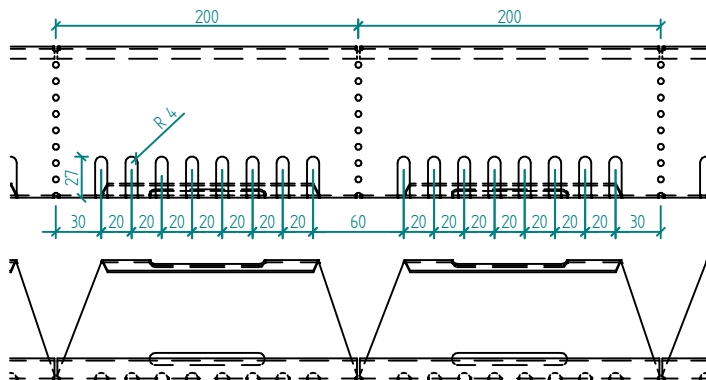

SP PROFIL

Název	Code	Materiál	Hmotnost	Tloušťka materiálu
SPKL O AL 150	020305_150_OAL15	Hliník AW 1050	1,845 kg	1,500 mm