

SPKL O AL 120

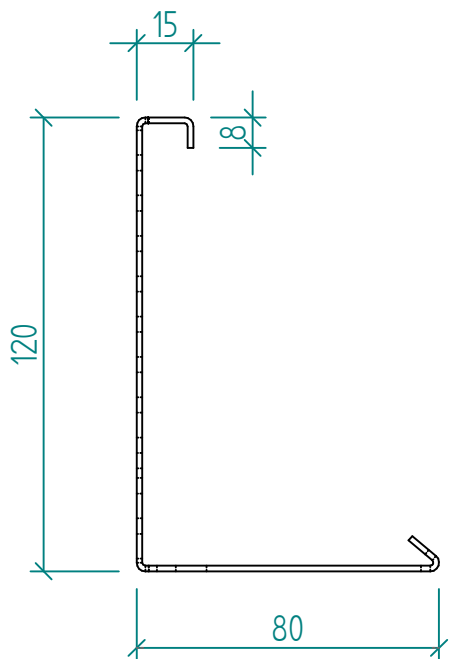

1:2

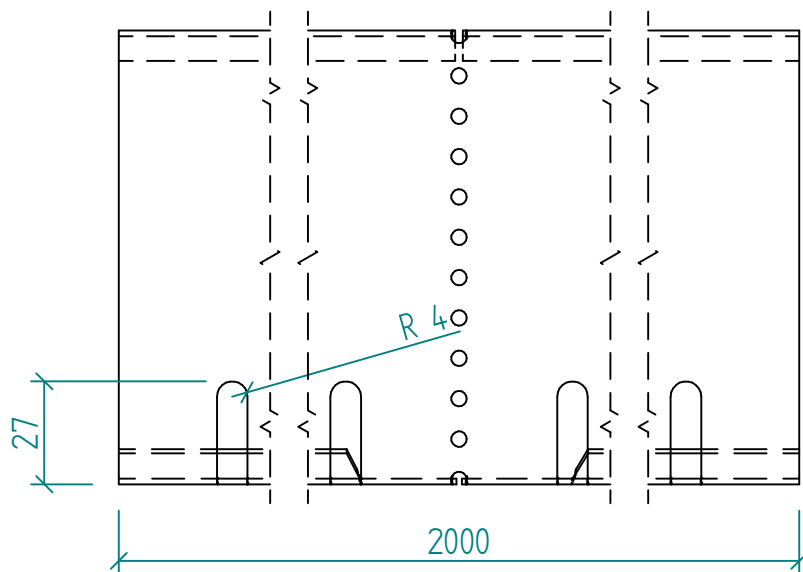

1:5

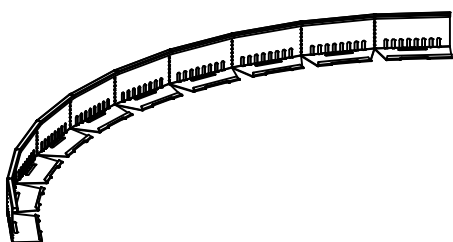
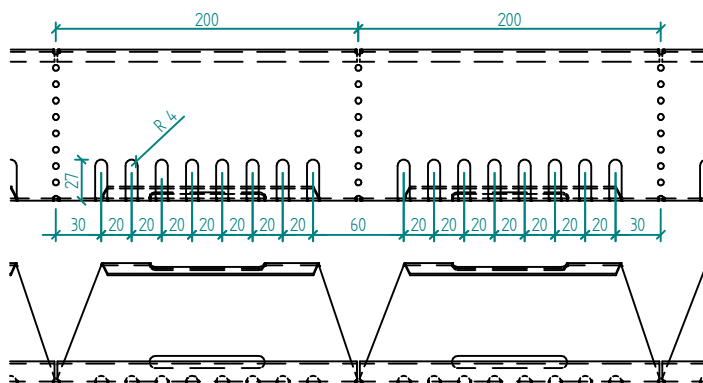

SP PROFIL

Název	Code	Materiál	Hmotnost	Tloušťka materiálu
SPKL O AL 120	020305_120_OAL15	Hliník AW 1050	1,602 kg	1,500 mm