

SPKL O AL 110

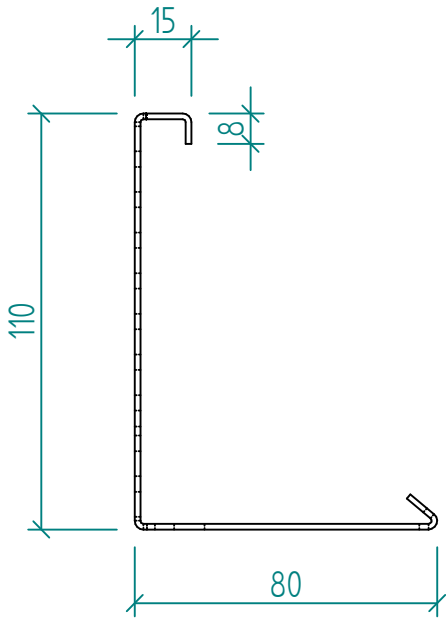

1:2

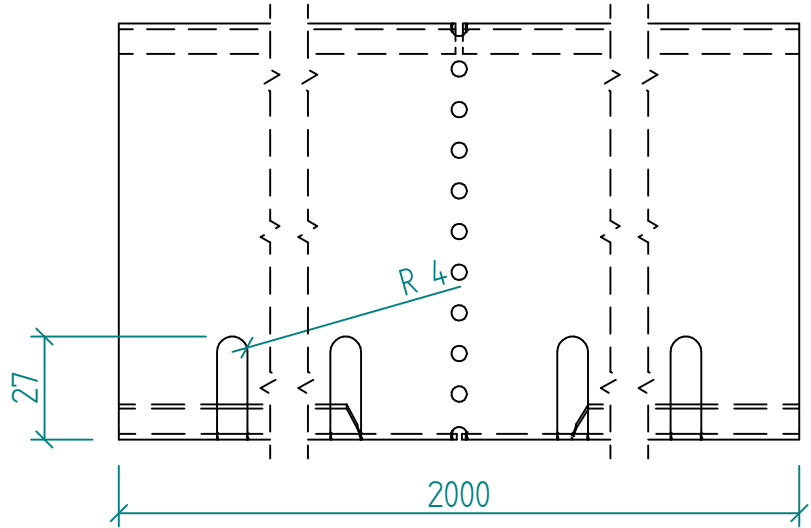

1:5

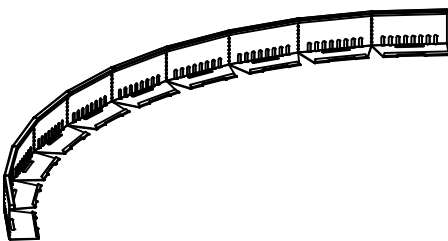
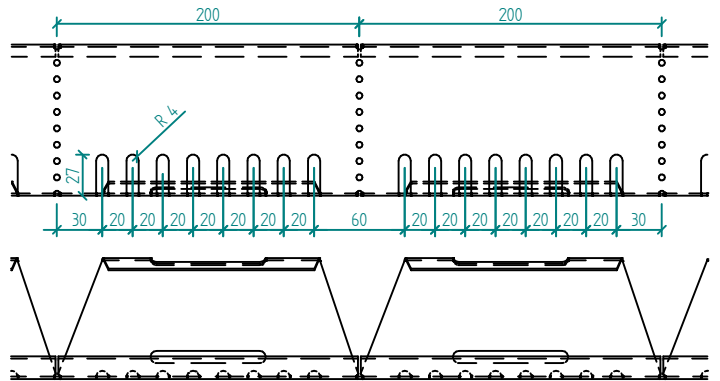

SP PROFIL

Název	Code	Materiál	Hmotnost	Tloušťka materiálu
SPKL O AL 110	020305_110_OAL15	Hliník AW 1050	1,521 kg	1,500 mm